



U.S. Department
of Transportation

**Federal Highway
Administration**

Indiana Division

575 North Pennsylvania Street, Room 254
Indianapolis, Indiana 46204

February 9, 2005

HDA-IN

Indiana City, Town and County
Engineers and Street Commissioners

Dear Sirs:

As many of you are aware the design and construction requirements for sidewalk curb ramps have been recently revised to require the use of detectable warning devices. The purpose of these devices is to warn those with visual impairment that they are at the edge of the street. The requirement to use detectable warning went into effect on July 26, 2001. Currently, truncated domes are the only detectable warning device that is acceptable to the U.S. Department of Transportation and the U.S. Access Board.

Our agency is responsible for assuring that curb ramps are provided and meet ADA requirements. Therefore, we are enclosing a copy of a December 20, 2004 Design Memorandum (Enclosure A) on this subject that has been issued by the Indiana Department of Transportation (INDOT). Attached to the Design Memorandum are the current design Standard Drawings and Specifications for curb ramps. INDOT is the State agency designated by Indiana law to develop the standards for use throughout the State.

The Design Memorandum, Standard Drawings and Specifications are self-explanatory. However, we would like to emphasize and further explain the following items:

TRUNCATED DOME MATERIALS

Currently, INDOT Specification 905.05, Detectable Warning Elements requires the use of truncated domes cast monolithically into high compressive strength clay bricks. This is the only type of material that can be used on Federal-aid highway projects in Indiana. This specification is on the last page of Enclosure A. However, there are many other types of materials used for this purpose such as concrete paving bricks, plastic, fiberglass and ceramics. You can use any of these materials on your locally funded work. Many states are currently experimenting with these materials and we will have more information on them in the future. To our knowledge, only truncated domes stamped in fresh concrete have proven to exhibit poor durability. The truncated domes wear off within one or two years. A list of Detectable Warning Manufacturers is shown on Enclosure B.



ALIGNMENT OF TRUNCATED DOMES

When constructing curb ramps the truncated domes should desirably be aligned so that the wheels of a wheelchair can pass between them in the desired travel direction. However, this is not an ADA requirement and may be difficult to accomplish with some types of curb ramps.

CURB RAMP TYPES

INDOT Standard Drawings show 10 types of curb ramps which can be used for different situations. The Type B curb ramp which is a diagonal ramp is the least desirable. It is located at the apex of the street corner and leads pedestrians toward the middle of the intersection. We strongly discourage its use. The Type A curb ramp is the most desirable and should be used at corners even though this will significantly increase cost. An alternate is to use a Type F curb ramp.

UTILITIES AND TRAFFIC CONTROL DEVICE SUPPORTS

It is often very difficult to locate curb ramps properly because of the presence of fire hydrants, light poles, sign supports, drainage inlets, etc. Therefore, it will be necessary to investigate all sites proposed for curb ramps and make a determination which items will have to be moved. Desirably, this should be done sufficiently in advance of the curb ramp construction to give the utility companies and other affected entities time to make the necessary relocations.

YELLOW PAINT

The surface of the curb throughout the width of the curb ramp must be painted yellow as required in INDOT Specification 604.03 (i) which is on the second to the last page of Enclosure A.

BOTTOM EDGE OF CURB RAMP

The bottom edge of curb ramps must be flush with the adjacent pavement or gutter line as required in INDOT Specification 604.03 (a) which is at the top of the third from the last page of Enclosure A. We often see this requirement violated. The reason that many agencies do not comply is that they desire to have a 1-inch drop at the bottom edge to maintain drainage in the gutter line. Unfortunately, when this is done it makes it very difficult for a person in a wheelchair to roll over the 1-inch lip.

SUBDIVISIONS

Many subdivision developers are not aware that if their developments have sidewalks they must comply with all ADA requirements including the installation of detectable warning elements. We recommend that they be required to comply before accepting their streets and sidewalks for city, town or county maintenance. If this is not done, your agency will be responsible for installing curb ramps or upgrading them to meet current standards.

ADA CURB RAMP PROGRAM

The Federal regulation implementing the ADA requires that all public entities that have sidewalks under their jurisdiction conduct a Self-evaluation and complete a Transition Plan (plan to install curb ramps on a priority basis). Enclosure C is a one-page article describing the actions that must be completed to comply with the regulation. If you have not already accomplished this, you should do so as soon as possible.

We hope that you find the enclosed material useful and informative. Should you have any questions concerning the content of this letter or the enclosures please contact our Design Engineer, Mr. Edward Ratulowski, Indiana FHWA at 317-226-7342.

If you are not the person responsible for the curb ramp program in your municipality or county please forward this information on to the appropriate person.

Sincerely,

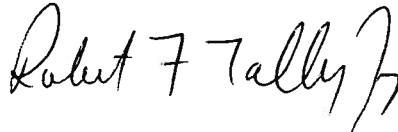
A handwritten signature in black ink that reads "Robert F. Tally, Jr." with a stylized flourish at the end.

Robert F. Tally, Jr., P.E.
Division Administrator

Enclosure

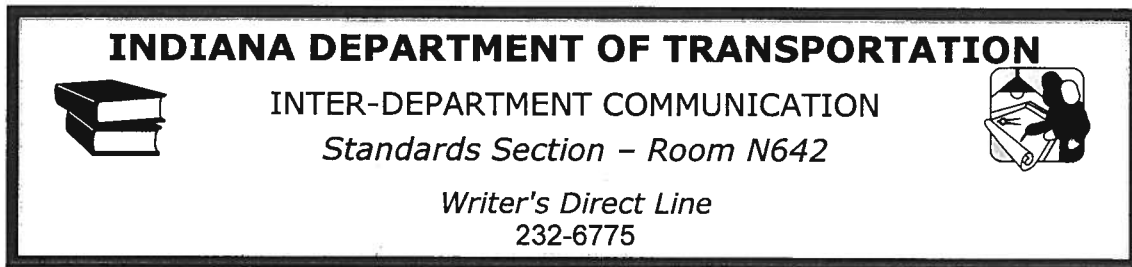

December 20, 2004

DESIGN MEMORANDUM No. 04-19

TECHNICAL ADVISORY

TO: All Design, Operations, District Personnel, and Consultants

FROM: /s/ Anthony L. Uremovich
Anthony L. Uremovich
Design Policy Engineer
Contracts and Construction Division

SUBJECT: Sidewalk Curb Ramps

SUPERSEDES: *Indiana Design Manual Section 51-1.08*

EFFECTIVE: May 25, 2005, Letting

Projects which include curbs and sidewalks at pedestrian crosswalks will require sidewalk curb ramps to eliminate physical barriers for ease of access to such crosswalks. A pedestrian crosswalk is defined as the portion of a street ordinarily included within the prolongation or connection of lateral lines of sidewalks at an intersection. It also includes any portion of a highway or street distinctly indicated as a crossing for pedestrians by means of lines or other markings on the pavement surface.

A curb ramp provides a sloped area within a public sidewalk that allows pedestrians to accomplish a change from sidewalk level to street level. A curb ramp typically includes the ramp and flared sides and specific surface treatments, but does not include the landings at the top and bottom of the ramp.

Curb ramps are to be placed at all crosswalks which extend from a paved sidewalk in each intersection with a curbed public roadway or curbed signalized commercial drive. Curb ramps should not be used at private drives, alleys, or unsignalized commercial drives. Instead, a sidewalk elevation transition as shown on Recurring Plan Details 604-R-484d, page 14 or 15 should be

placed. At T-intersections, the designer should ensure that curb ramps are located on the side opposite the minor intersecting road if a sidewalk is present or is to be provided.

For partial 3R projects, curb ramps should be considered as described in *Indiana Design Manual* Chapter Fifty-six. Curb ramps should not be considered for signing, pavement marking, or roadway lighting projects.

A. Location

When determining the locations of curb ramps, the designer should consider the following:

1. Curb ramps should be located directly opposite one another for each crosswalk, and should be placed within the transverse limits of crosswalk lines, where crosswalk lines are used.

The placement of curb ramps affects the placement of crosswalk lines and vehicle stop lines. Conversely, the location of existing crosswalk lines and stop lines affect the placement of curb ramps. Some of the crosswalk-line constraints are shown in Figure 04-19A, Types of Curb Ramps at Marked Crossings, and in Recurring Plan Details. The *Manual on Uniform Traffic Control Devices* contains additional constraints on crosswalk- and stop-line placement.

2. Each ramp should be designed and placed to provide continuity of the sidewalk corridor direction of travel while providing pedestrians the shortest but most direct route across a street.
3. The designer should ensure that the landing area at the bottom of each curb ramp does not encroach upon through-lane vehicle traffic which has the right of way at the same time a pedestrian is attempting to use the crosswalk parallel to it.
4. The curb ramp and associated landings should not be compromised by other highway features (e.g., guardrail, catch basins, utility poles, fire hydrants, sign or signal supports, etc.).
5. There should be full continuity of use throughout. Opposing curb ramps should always be provided in all required intersection quadrants, including intersections with some quadrants outside the project limits.
6. Curb ramps should be located or protected to prevent their obstruction by parked vehicles.

7. Approval of a Level One waiver of the accessibility requirements for physically impaired individuals is required for locations where there are valid reasons to restrict or prohibit pedestrian access. Such waiver is described in *Indiana Design Manual* Section 40-8.04(01) Item 2.
8. The normal gutter flow line should be maintained through the curb ramp area. Appropriate drainage structures should be placed as needed to intercept the flow prior to the curb ramp area. Positive drainage should be provided to carry water away from the intersection of the curb ramp and the gutter line, thus minimizing the depth of any flow across the crosswalk.
9. If modifications to the details shown on the INDOT Standard Drawings are required so that a curb ramp can be better accommodated, such details and the required pay quantities should be shown on the plans.
10. The impact of utilities location on curb-ramp placement and construction should be minimized. The designer is responsible for being aware of potential utility conflicts. If utilities are present, coordination should be in accordance with Section 10-2.0.

B. Types of Sidewalk Curb Ramps

Details for placement of curb ramps and an illustration showing appropriate locations for all curb ramp types are shown on Recurring Plan Details 604-R-486d, page 1. Determining which curb ramp is most appropriate depends on the exact conditions of the site. Curb ramps are categorized below by their structural design and how they are positioned to the sidewalk or street.

1. Perpendicular Curb Ramp. This curb ramp is perpendicular to the curb and requires a wide enough sidewalk to provide a 12:1 running slope. **This is the preferred design.** The length of the ramp depends on the height of the curb where the ramp is to be located. Details of a ramp with an integral curb and of a ramp with a separate curb are shown on Recurring Plan Details 604-R-484d, pages 3 and 5, respectively. A landing should be provided at the top of the ramp. If site infeasibility precludes construction as shown on Recurring Plan Details 604-R-484d, pages 3, 5, or 6, the level landing width may be decreased from 1200 mm to 900 mm (4 ft to 3 ft), and the running slope may be increased to 10:1 for a maximum 150 mm (6 in.) rise. New construction should always provide adequate right of way for a perpendicular curb ramp. Some portion of the curb ramp, typically one of the flared sides, may fall within the curved intersection corner. See Recurring Plan Details 604-R-484d, page 12 for details of improved access to perpendicular curb ramps.

The standard perpendicular curb ramps are as follows:

- a. Type A. This type should be specified where a curb ramp is required entirely within the pedestrian walkway. It is the preferred type where the sidewalk is adjacent to the curb.
- b. Type C. This type should be specified where a curb ramp is required outside the pedestrian walkway, in the utility strip. It is the preferred type where there is a utility strip between the sidewalk and the curb.
- c. Type D. This type should be specified where a curb ramp is required near an obstruction which can not be removed. It is the preferred type for this situation, and may be used with or without a utility strip present.

2. Diagonal Curb Ramp. A diagonal curb ramp is a single curb ramp that is located at the apex of the corner at an intersection, and serves two intersecting crossing directions. Since the ramp is diagonal to the path of travel, it is only accessible if level landing or maneuvering spaces are provided at both the top and bottom of the ramp. If creating a level landing is too difficult or a 1.2-m (4-ft) clear space cannot be provided, a diagonal curb ramp should not be considered. If site infeasibility precludes construction as shown on Recurring Plan Details 604-R-484d, page 4 or 7, the landing width may be decreased from 1.2 m to 0.9 m (4 ft to 3 ft) and the running slope may be increased to 10:1 for a maximum 150 mm (6 in.) rise.

Diagonal curb ramps should only be used where perpendicular or parallel curb ramps are infeasible and no other option is available, or if a field investigation warrants their use for alterations affecting existing sidewalks.

If diagonal curb ramps are to be used, durable crosswalk markings are required on the street pavement. Specific constraints for crosswalk markings and stop-lines placement are shown on Figure 04-19A, Types of Curb Ramps at Marked Crossings. Each diagonal curb ramp should be wholly contained within the crosswalk lines, including any flared sides. There should be at least 1.2 m (4 ft) between the gutter line and the corner of the two intersecting crosswalk lines as delineated within the intersection pavement area. See Figure 04-19A for an illustration of these criteria.

The standard diagonal curb ramps are as follows:

- a. Type B. This type should be specified where a curb ramp is required entirely within the pedestrian walkway, the corner radius is greater than 3 m (10 ft), and placement of a Type A ramp is infeasible. At the bottom of the ramp, the perimeter length is 2.4 m (8 ft), regardless of the corner radius.

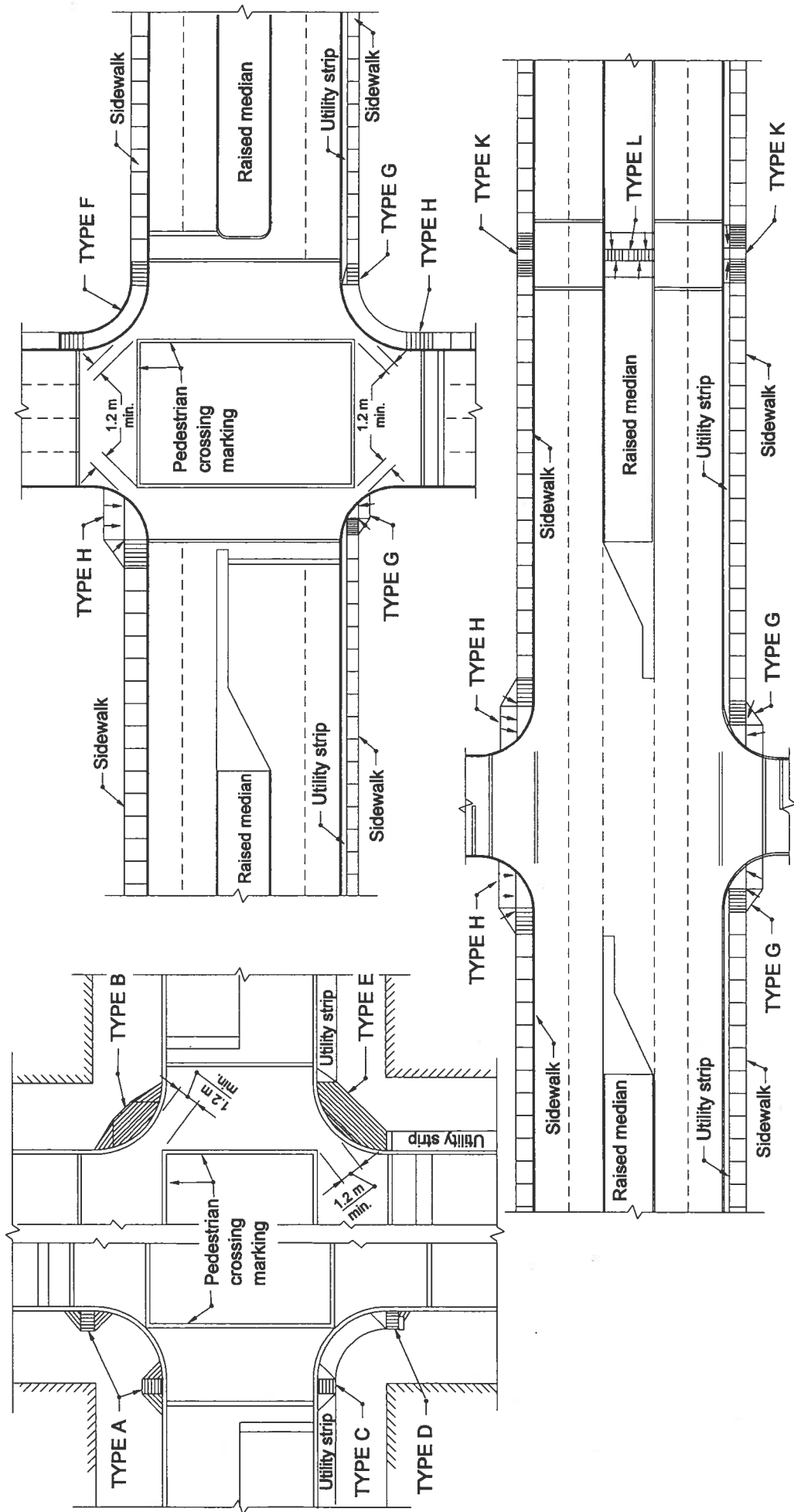

TYPES OF CURB RAMPS AT MARKED CROSSINGS

Figure 04-19A

- b. Type E. This type should be specified where a curb ramp is required outside the pedestrian walkway in the utility strip, the corner radius is greater than 3 m (10 ft), and placement of a Type B ramp is infeasible.

This type should also be specified where a curb ramp is required outside the pedestrian walkway in the utility strip, the corner radius is greater than 3 m (10 ft), an obstruction which cannot be removed is present, and placement of a Type C ramp is infeasible.

At the bottom of the ramp, the perimeter length is 2.4 m (8 ft), regardless of the corner radius.

- 3. Parallel Curb Ramp. A parallel curb ramp has two ramps leading down towards a center level landing at the bottom between both ramps and has level landings at the top of each ramp. A parallel curb ramp may be specified for a narrow sidewalk, steep terrain, or at a location with a high curb, as the ramp can easily be lengthened to reduce the grades. A parallel curb ramp should not be installed where it is possible to install two perpendicular curb ramps. A wall or curb may be required along the back edge of the ramp as shown on Recurring Plan Details 604-R-484d, page 8. The designer should show details for such wall or curb on the plans and include a unique special provision.

Parallel curb ramps should only be used where perpendicular curb ramps are infeasible and no other option is available.

The standard parallel curb ramp is type F. This type should be specified where the corner radius at least 4.5 m (15 ft) but less than 7.5 m (25 ft), and only if a field investigation warrants its use for alterations affecting existing sidewalks.

- 4. Depressed-Corners Curb Ramp. Depressed corners gradually lower the level of the sidewalk to meet the grade of the road, street, or signalized approach. This curb ramp should be specified only at a corner where the sidewalk parallels only one of the intersecting roadways.

The standard depressed-corners curb ramps are as follows:

- a. Type H. This type should be specified where the sidewalk is adjacent to the curb.
- b. Type G. This type should be specified where there is a utility strip between the sidewalk and the curb.

5. Mid-Block Curb Ramp, Type K. This type should be specified at a mid-block location. It may be used where the sidewalk is adjacent to the curb or where there is a utility strip between the sidewalk and the curb.
6. Median Curb Ramp, Type L. This type should be specified where a raised paved or unpaved median of 2.4 m (8 ft) or greater width obstructs the crosswalk. Where the median width is less than 2.4 m (8 ft), a detail should be shown on the plans.

C. Selection Guidelines

The following provides guidelines for selecting the appropriate curb ramp.

1. Sidewalk and Utility-Strip Widths. The INDOT *Standard Drawings* show minimum sidewalk widths and utility-strip widths. These minimum widths are intended for new construction and reconstruction, typically to construct perpendicular curb ramps. Parallel curb ramp type F may be used where an existing sidewalk cannot be widened to the minimum width.
2. Obstructions. It is desirable to move an obstruction wherever practical. Where it is not practical to move the obstruction, the direction of traffic relative to the placement of the curb ramp should be considered. It is important that drivers can see a physically impaired person using the curb ramp. Where obstructions are present, such as signal controller boxes, planters, signal pole bases, etc., a perpendicular curb ramp type D should be used. No obstruction should be permitted within flared sides which are paved.
3. Best Practices. The following should be considered.
 - a. A level maneuvering area or landing should be provided at the top of each curb ramp.
 - b. The ramp slope should be perpendicular to the curb, with a maximum of 8.33%. Details regarding curb ramp slopes are shown on Recurring Plan Details 604-R-484d, page 2.
 - c. The counterslope of the gutter area or street at the flat of a curb ramp should be a minimum of 20:1.
 - d. Curb-ramp geometrics to be used are summarized in Figure 04-19B.

Type	Ramp Width (m)	Ramp Slope	Landing Width (m)	Landing Depth (m)	Flare Slope	Clear Space (m)
PERPENDICULAR						
A	1.2 ¹	12:1 ²	1.2	1.2 ¹	12:1, Pvmt.	N/A
C	1.2 ¹	12:1 ²	1.2	1.2 ¹	12:1, Pvmt.	N/A
D	1.2 ¹	12:1 ²	1.2	1.2 ¹	12:1, Pvmt.	N/A
DIAGONAL						
B	1.2 ¹ to 2.4	12:1 ²	N/A	1.2 top & bot	12:1, Pvmt.	1.2
E	1.6 to Vari	12:1 ²	0 to 1.6	1.2	12:1, Sod	1.2
PARALLEL						
F	Sdwk.	12:1	Sdwk.	1.2	N/A	1.2
DEPRESSED-CORNERS						
H	1.8	12:1	1.8	1.8	12:1, Sod ³	1.2
G	1.5	12:1	1.5	1.5	12:1, Sod ³	1.2
MID-BLOCK						
K	1.2	12:1	1.2 ¹	Sdwk.	N/A	N/A
MEDIAN						
L	1.6	50:1	1.6	N/A	12:1, MM ⁴	N/A

¹ If 1.2-m width or depth is site-infeasible, it may be reduced to 0.9 m.

² If 12:1 slope is site-infeasible, it may be steepened to 10:1 for a rise of not more than 150 mm.

³ If 1.8-m depth is site-infeasible, this may be steepened or replaced with a vertical curb.

⁴ MM = median material.

5. The landing cross slope should be 50:1, but if it is site-infeasible, it may be steepened.

6. The landing slope should be 50:1, the maximum longitudinal gutter slope should be 20:1, and the width of the area with detectable warning devices should be 0.6 m.

SUMMARY OF CURB-RAMP GEOMETRICS (Metric Units)

Figure 04-19B

Type	Ramp Width (ft)	Ramp Slope	Landing Width (ft)	Landing Depth (ft)	Flare Slope	Clear Space (ft)
PERPENDICULAR						
A	4 ¹	12:1 ²	4	4 ¹	12:1, Pvmt.	N/A
C	4 ¹	12:1 ²	4	4 ¹	12:1, Pvmt.	N/A
D	4 ¹	12:1 ²	4	4 ¹	12:1, Pvmt.	N/A
DIAGONAL						
B	4 ¹ to 8	12:1 ²	N/A	4 top & bot	12:1, Pvmt.	4
E	5.5 to Vari	12:1 ²	0 to 5.5	4	12:1, Sod	4
PARALLEL						
F	Sdwk.	12:1	Sdwk.	4	N/A	4
DEPRESSED-CORNERS						
H	6	12:1	6	6	12:1, Sod ³	4
G	5	12:1	5	5	12:1, Sod ³	4
MID-BLOCK						
K	4	12:1	4 ¹	Sdwk.	N/A	N/A
MEDIAN						
L	5.25	50:1	5.25	N/A	12:1, MM ⁴	N/A

¹ If 4-ft width or depth is site-infeasible, it may be reduced to 3 ft.

² If 12:1 slope is site-infeasible, it may be steepened to 10:1 for a rise of not more than 6 in.

³ If 6-ft depth is site-infeasible, it may be steepened or replaced with a vertical curb.

⁴ MM = median material.

5. The landing cross slope shall be 50:1, but if it is site-infeasible, it may be steepened.

6. The landing slope should be 50:1, the maximum longitudinal gutter slope should be 20:1, and the width of the area with detectable warning devices should be 2 ft.

SUMMARY OF CURB RAMP GEOMETRICS (English Units)

Figure 04-19B

D. Curb Ramp Lengths and Slopes

Curb ramps should be designed with a maximum slope of 12:1, or 8.33%. See Figure 04-19C, Lengths of Perpendicular Curb Ramps, to determine the length of a curb ramp which is perpendicular to the curb. The figure assumes a 2% sidewalk cross slope and a level longitudinal grade.

Change in Elevation, mm	Ramp Length, m
100	1.6
125	2.0
150	2.4
175	2.8
200	3.2

Metric Units

Change in Elevation, in.	Ramp Length, ft
4	5.5
5	6.5
6	8.0
7	9.0
8	11.0

English Units

LENGTHS OF PERPENDICULAR CURB RAMPS

Figure 04-19C

For a curb ramp which is not perpendicular to the curb, the following formula should be used to determine its length. The formula assumes a 2% sidewalk cross slope and a level longitudinal grade.

$$L_{CR} = \frac{h}{\cos \theta (G_R - G_S)} \quad \text{[Equation 04-19D.1]}$$

Where:

L_{CR} = Curb ramp length, m (ft)

H = Change in elevation, m (ft)

G_R = Curb ramp grade, % / 100

G_S = Sidewalk cross grade, % / 100

θ = Angle to which the curb ramp is out of perpendicular to the curb

E. Algebraic Difference Between Curb Ramp and Gutter Slopes

The algebraic difference between a curb ramp slope and the gutter or pavement slope should be less than 11%. If this is not possible, a 0.6-m (2-ft) wide level strip should be provided between the grades. See Recurring Plan Details 604-R-484d, page 2.

$$\Delta G = |G_R - G_G|$$

[Equation 04-19D.2]

Where:

ΔG = Algebraic grade difference, %

G_R = Ramp grade, %

G_G = Gutter grade, %

$|G_R - G_G|$ = Absolute value of grade difference, %

A level strip is required if $\Delta G \geq 11\%$.

F. Detectable Warning Devices

Sidewalk curb ramps are to include detectable warning devices. These consist of a standardized surface feature to warn people with vision impairments that they are approaching a street or driveway. The color and texture of these devices must contrast visually with adjoining surfaces. Details and explanations are shown on Recurring Plan Details 604-R-484d, page 2 and the INDOT *Standard Specifications*, respectively.

G. Pedestrian Signal Controls

If a pedestrian crosswalk and curb ramp are present at an intersection with a traffic signal that has pedestrian-signal-activating pushbuttons, the following will apply.

1. Location. Pushbutton controls should be located as close as practical to the curb ramp and, to the maximum extent feasible, should permit operation from a level area immediately adjacent to the controls. Controls should be placed so as not to create an obstruction to the curb ramp.
2. Surface. A sidewalk area of 1.2 m by 1.2 m (4 ft by 4 ft) should be provided to allow a forward or parallel approach to the controls. In a restricted area, such sidewalk area may be reduced to 0.9 m by 0.9 m (3 ft by 3 ft).

H. Pay Limits and Pay Quantities

The pay limits for curb ramps are shown on Recurring Plan Details 604-R-486d, page 13. The approximate pay quantity for each type of curb ramp is described in Figure 04-19D, Quantities for Curb Ramps. Quantities for curb or curb and gutter within the curb ramp limits should be incorporated into the project's appropriate curb or curb-and-gutter quantities. Quantities for sidewalk required outside the curb ramp pay limits, including those for additional landing area or improved access area, should be incorporated into the project concrete sidewalk quantities. If flared sides are sod instead of concrete, such sodding should be incorporated into the project sodding quantities.

Curb Ramp Type	150-mm Curb		200-mm Curb	
	Assumptions for Calculation Purposes (Top Landing Not Incl. in Area), All Dimens. m	Area (m ³)	Assumptions for Calculation Purposes (Top Landing Not Incl. in Area), All Dimens. m	Area (m ³)
A	Sdwk. width 3.6	5.4	Sdwk. width 4.5	8.6
B	Sdwk. width 4; R = 3	13.6	Sdwk. width 4.5; R = 3	18.2
	Sdwk. width 5.5; R = 7.5	18.0	Sdwk. width 6; R = 7.5	25.5
C	Utility-strip width 1.8	2.2	Utility-strip width 2.4	2.9
D	Utility-strip width 1.8	2.2	Utility-strip width 2.4	2.9
E	Utility-strip width 3 (one side only); Sdwk. W = 1.2, R = 3	8.9	Not possible to construct on utility-strip width of 3	n/a
	Sdwk. W = 2.1, R = 7.5	4.8		
F	Sdwk. width 1.2; R = 4.5	12.0	Sdwk. width 1.2; R = 4.5	13.0
	Sdwk. width 1.2; R = 7.5	18.0	Sdwk. width 1.2; R = 7.5	20.0
G	Sdwk. 1.5, Util. 1.8; R = 7.5	4.0	Sdwk. 1.5, Util. 1.8; R = 7.5	5.0
H	Sdwk. Width 1.8; R = 7.5	5.3	Sdwk. Width 1.8; R = 7.5	6.4
K	Sdwk. width 1.5	7.4	Sdwk. width 1.5	9.3
L	Grass median width 5	8.0	Grass median width 5	8.0

QUANTITIES FOR CURB RAMPS (Metric Units)

Figure 04-19D

Curb Ramp Type	6-in. Curb		8-in. Curb	
	Assumptions for Calculation Purposes (Top Landing Not Incl. in Area), All Dimens. ft	Area (SYS)	Assumptions for Calculation Purposes (Top Landing Not Incl. in Area), All Dimens. ft	Area (SYS)
A	Sdwk. width 10	7.0	Sdwk. width 12	11.1
B	Sdwk. width 13; R = 10	16.4	Sdwk. width 15; R = 10	19.4
	Sdwk. width 18; R = 25	21.4	Sdwk. width 20; R = 25	30.6
C	Utility-strip width 6	2.7	Utility-strip width 8	3.5
D	Utility-strip width 6	2.7	Utility-strip width 8	3.5
E	Utility-strip W = 10 (one side only); Sdwk. W = 4, R = 10	10.7	Not possible to construct on utility-strip width of 10	n/a
	Sdwk. W = 7, R = 25	6.0		
F	Sdwk. width 4; R = 15	14.3	Sdwk. width 4; R = 15	16.1
	Sdwk. width 4; R = 25	21.6	Sdwk. width 4; R = 25	23.3
G	Sdwk. 5, Util. 6; R = 25	4.9	Sdwk. 5, Util. 6; R = 25	6.0
H	Sdwk. Width 6; R = 25	6.3	Sdwk. Width 6; R = 25	7.7
K	Sdwk. width 5	8.9	Sdwk. width 5	11.1
L	Grass median width 16	9.3	Grass median width 16	9.3

**QUANTITIES FOR CURB RAMPS
(English Units)**

Figure 04-19D

I. Implementation

Plans and contract documents must be revised such that curb ramps are not shown to be placed at drives. Instead a sidewalk elevation transition should be shown to be placed. Where feasible, the preferred types of curb ramps should be shown to be placed.

Recurring Plan Details set 604-R-484d, attached hereto, should be called for through the August 17, 2005, letting. Beginning with the September 14, 2005, letting, the recurring plan details will be incorporated into revised INDOT *Standard Drawings* series 604-SWCR and 604-SDWK. The details will then no longer be required to be called for in specific contracts.

alu

Attachments

[F:\Des\Signed\0419-ta.doc]

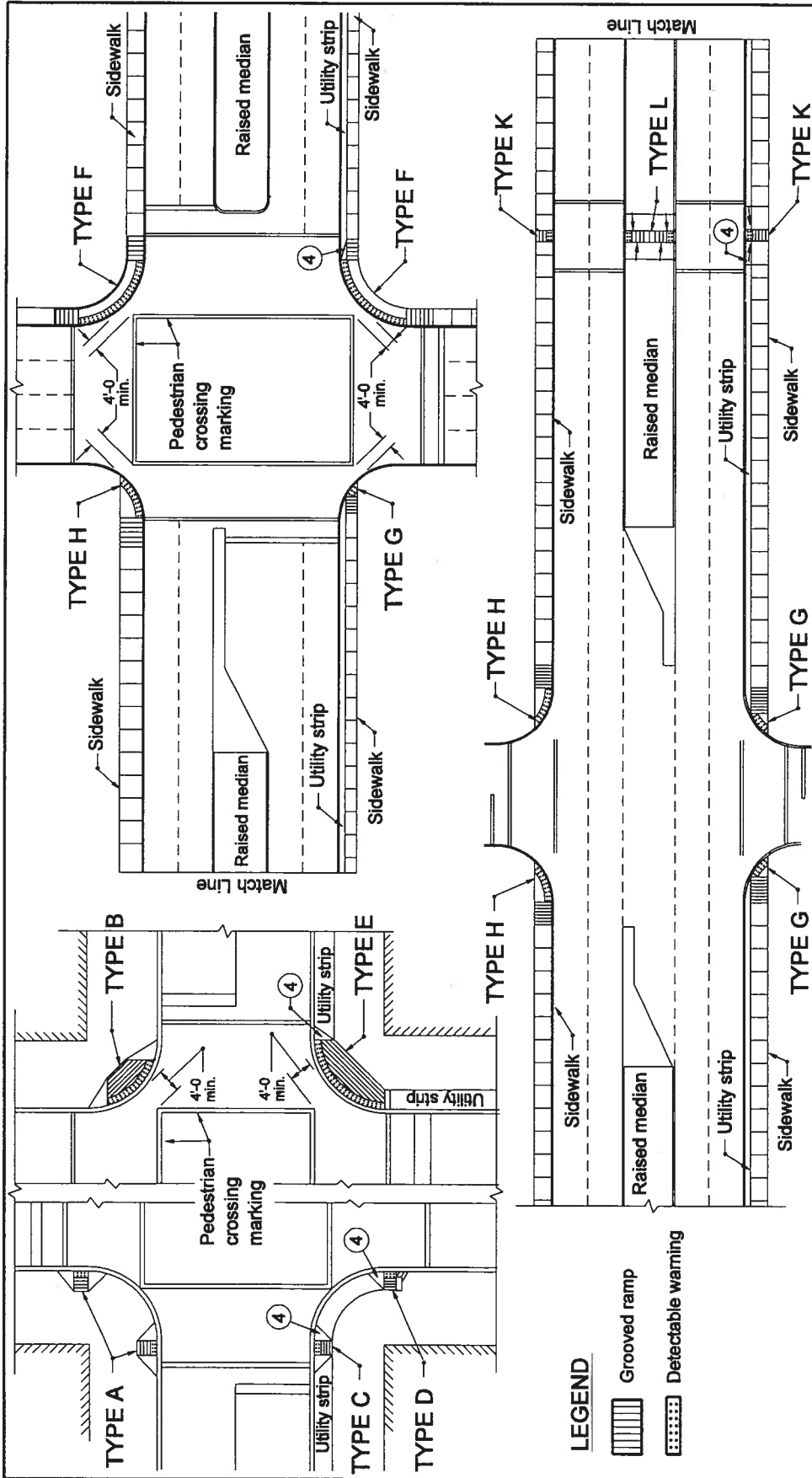

LEGEND

-  Grooved ramp
-  Raised median
-  Detectable warning

1. The curb ramp type includes the ramp and flared sides as indicated on the details. A level landing shall be provided at the high end of every curb ramp.
2. For details of sidewalk curb ramp types see Standard Drawings E 604-SWCR-03 to -11.
3. The curb ramps shall be placed within the marked crosswalk area.
4. Flared side of sidewalk curb ramp next to utility strip shall be sodded.
5. See Standard Drawing E 604-SWCR-02 for General Notes.

INDIANA DEPARTMENT OF TRANSPORTATION
 LOCATION PLAN FOR
 SIDEWALK CURB RAMPS
 11/01/04

GENERAL NOTES :

- 1 These dimensions are based on a 6 in. curb height. They shall be proportionally adjusted for other curb heights.
- 2 Where site infeasibility precludes construction to the width shown, such width may be decreased to a minimum of 3'-0.
- 3 The bottom edge of the curb ramp shall be flush with the edge of adjacent pavement and gutter line.
- 4 Landing areas at the top of curb ramps shall have maximum cross slope of 50 : 1 in any direction. When site infeasibility precludes a landing slope of 50 : 1 in any direction, the slope perpendicular to the curb face shall not exceed 50 : 1.
- 5 If site infeasibility precludes construction to the width shown, the landing width may be decreased to 3'-0 minimum. The running slope of the curb ramp may be steepened to a maximum of 10 : 1 for a maximum 6 in. rise.
- 6 Drainage inlets should be located uphill from curb ramps to prevent puddles at the path of travel.
7. See Standard Drawing E 604-SWCR-12 for improved access on narrow sidewalks.
8. Algebraic difference in grade between the base of curb ramp and the gutter shall be limited to less than 11%. If it is not practical, a 2'-0 wide level strip shall be provided. See detail sketch.
9. Minimum recommended width of curb ramp is 4'-0.

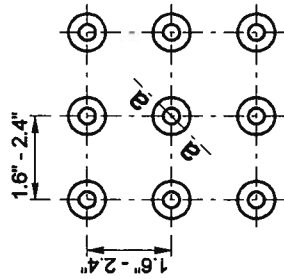

Square pattern

TRUNCATED DOMES USED IN DETECTABLE WARNINGS

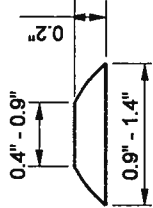

Section a-a

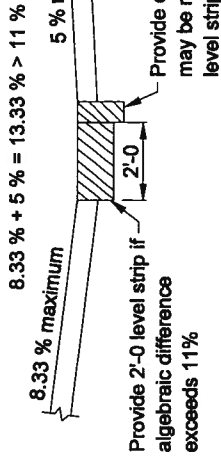

CHANGE OF GRADE

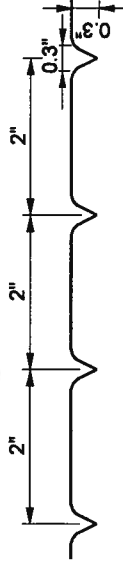

DETAIL OF RAMP GROOVES

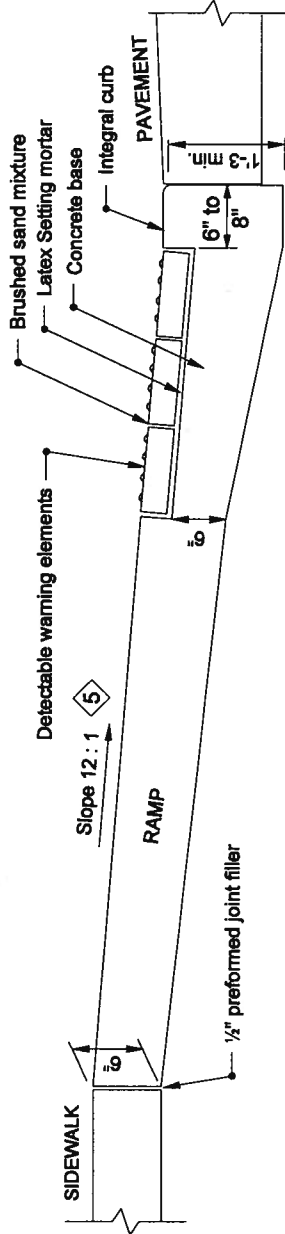

RAMP AND BRICK SURFACE CONSTRUCTION DETAIL

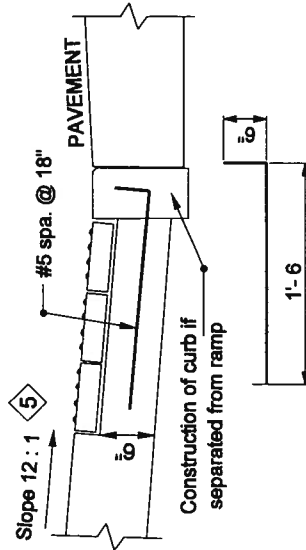

ALTERNATE CURB CONSTRUCTION

INDIANA DEPARTMENT OF TRANSPORTATION
 SIDEWALK CURB RAMPS
 GENERAL NOTES & DETAILS
 11/01/04

NOTES:

- ⑥ See Standard Drawing E 604-SWCR-02 for groove details.
- ⑦ See Standard Drawing E 604-SWCR-02 for details of the detectable warning.
- ⑧ See Standard Drawing E 604-SWCR-02 for alternate curb construction.
- 10. See Standard Drawing E 604-SWCR-01 and -02 for Location Plan and General Notes respectively.
- 11. See Standard Drawing E 604-SWCR-02 for typical ramp construction detail.

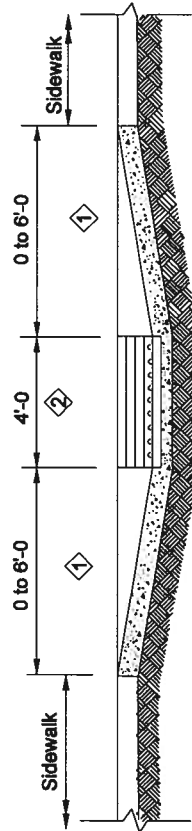
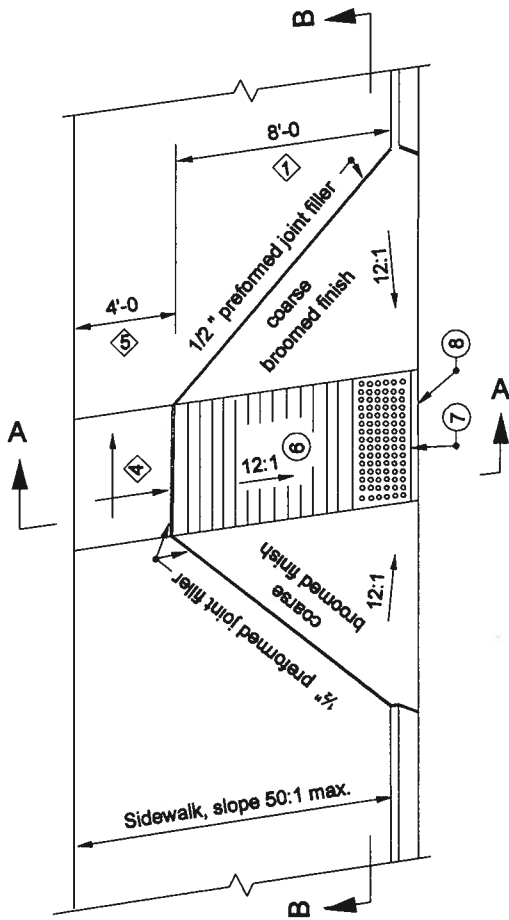

SECTION B-B

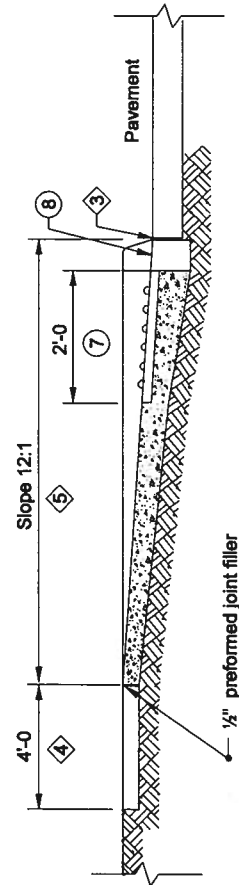

SECTION A-A

INDIANA DEPARTMENT OF TRANSPORTATION
 SIDEWALK CURB RAMP
 TYPE A
 11/01/04

NOTES :

- ⑥ See Standard Drawing E 604-SWCR-02 for groove details.
- ⑦ See Standard Drawing E 604-SWCR-02 for details of the detectable warnings.
- ⑧ See Standard Drawing E 604-SWCR-02 for alternate curb construction.
- 9. See Standard Drawing E 604-SWCR-02 for typical ramp construction detail.
- 10. See Standard Drawing E 604-SWCR-01 and -02 for Location Plan and General Notes respectively.

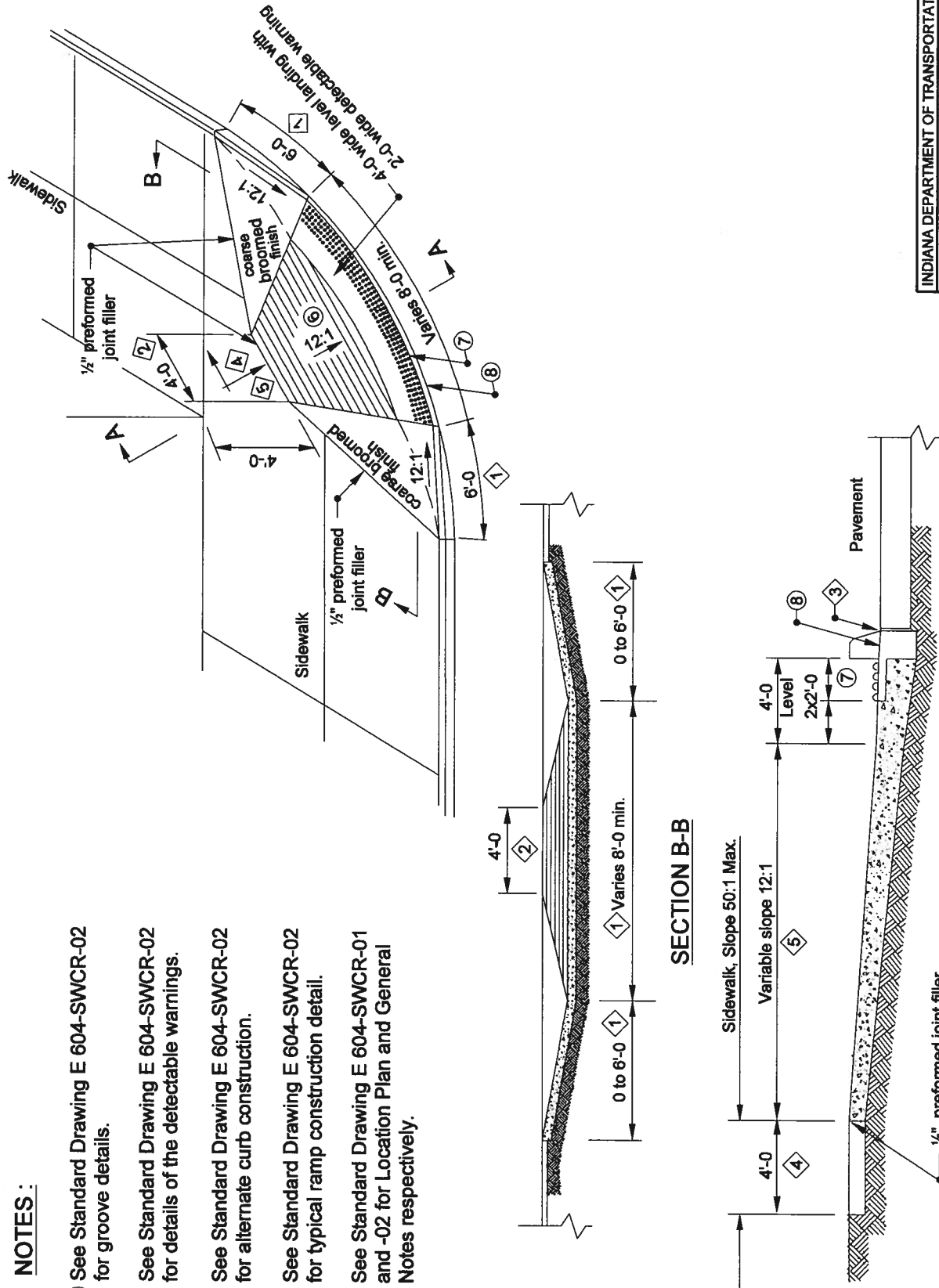

INDIANA DEPARTMENT OF TRANSPORTATION
 SIDEWALK CURB RAMP
 TYPE B
 11/01/04

NOTES:

- ⑥ See Standard Drawing E 604-SWCR-02 for groove details.
- ⑦ See Standard Drawing E 604-SWCR-02 for details of the detectable warning surface.
- ⑧ See Standard Drawing E 604-SWCR-02 for alternate curb construction.
- 9. See Standard Drawing E 604-SWCR-02 for typical ramp construction detail.
- 10. See Standard Drawing E 604-SWCR-01 and -02 for Location Plan and General Notes respectively.

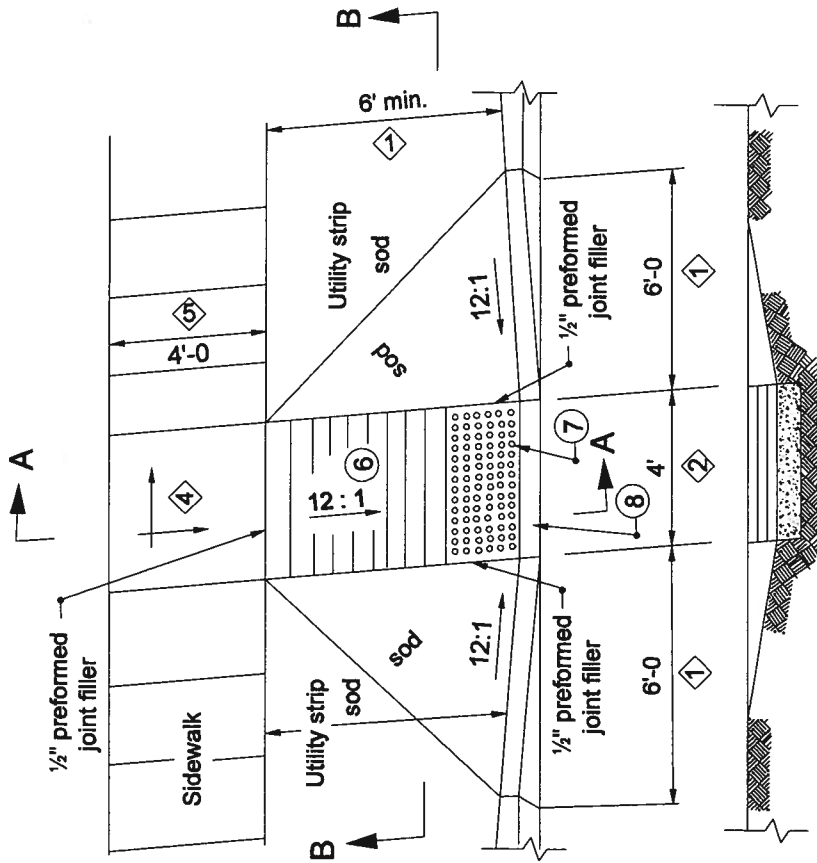

SECTION B-B

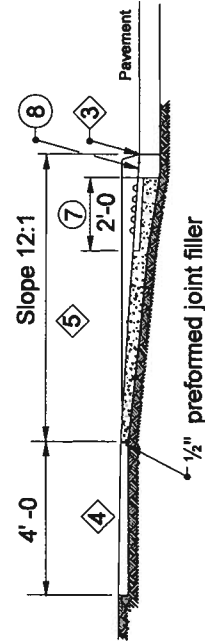

SECTION A-A

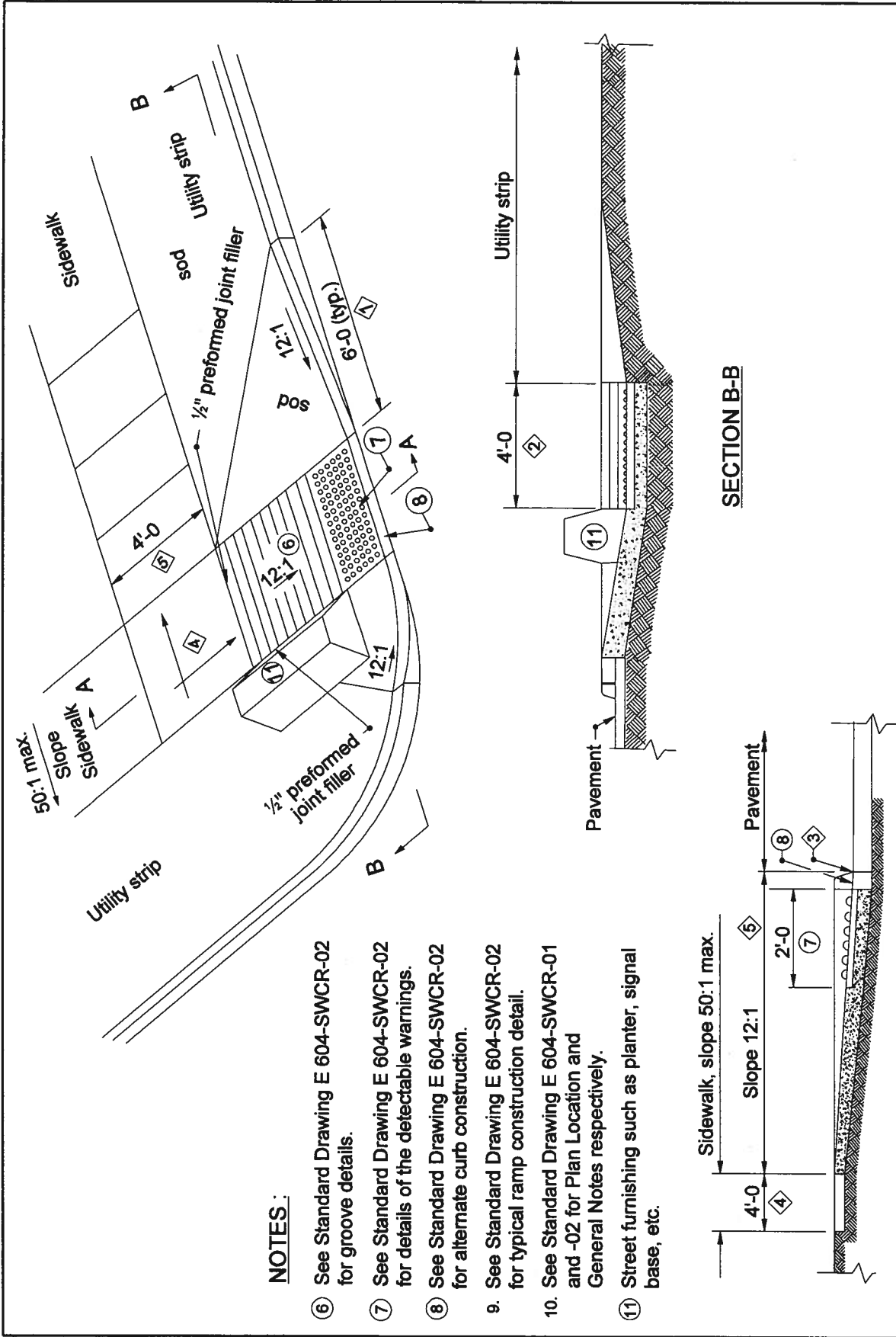

NOTES:

- ⑥ See Standard Drawing E 604-SWCR-02 for groove details.
- ⑦ See Standard Drawing E 604-SWCR-02 for details of the detectable warnings.
- ⑧ See Standard Drawing E 604-SWCR-02 for alternate curb construction.
- 9. See Standard Drawing E 604-SWCR-02 for typical ramp construction detail.
- 10. See Standard Drawing E 604-SWCR-01 and -02 for Plan Location and General Notes respectively.
- ⑪ Street furnishing such as planter, signal base, etc.

SECTION B-B

SECTION A-A

INDIANA DEPARTMENT OF TRANSPORTATION
 SIDEWALK CURB RAMP
 TYPE D
 11/01/04

NOTES:

- ⑥ See Standard Drawing E 604-SWCR-02 for groove details.
- ⑦ See Standard Drawing E 604-SWCR-02 for details of detectable warning surface.
- ⑧ See Standard Drawing E 604-SWCR-02 for alternate curb construction.
- ⑨ See Standard Drawing E 604-SWCR-02 for typical ramp construction detail.
- ⑩ See Standard Drawing E 604-SWCR-01 and -02 for Plan Location and General Notes respectively.
- ⑪ Street furnishing such as planter, signal base, etc.

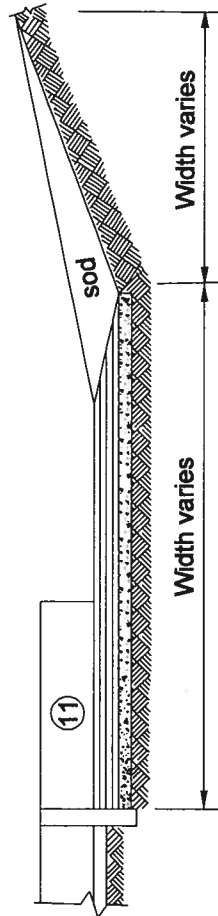
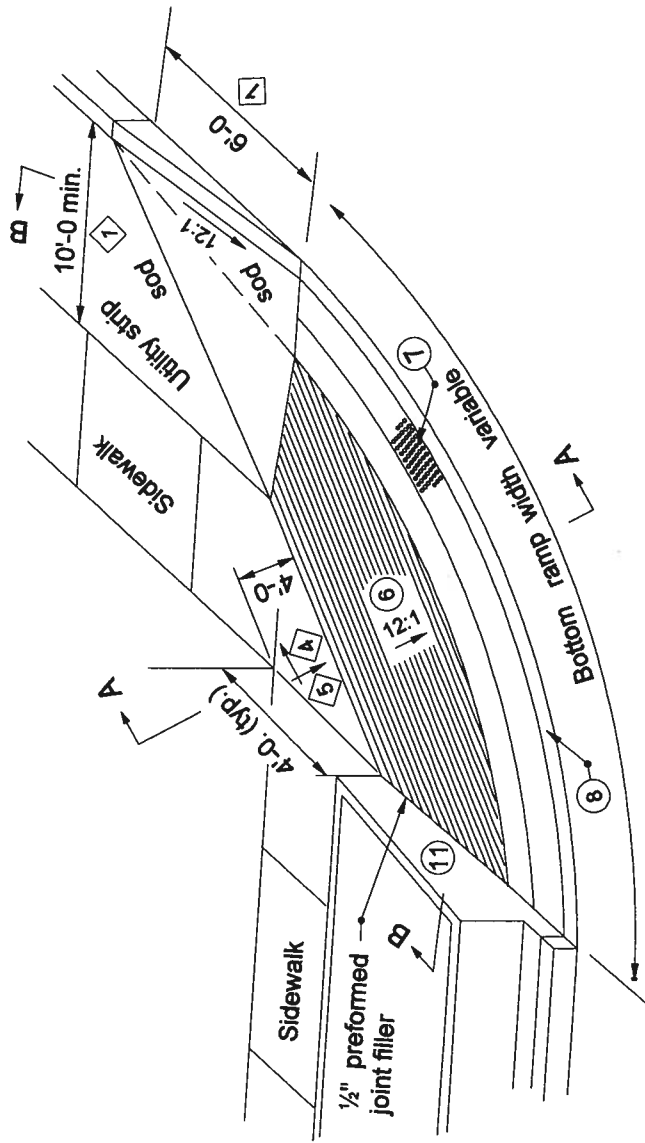

SECTION B-B

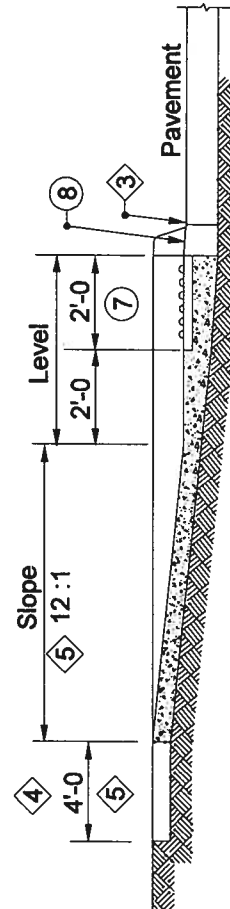

SECTION A-A

NOTES :

- ⑥ See Standard Drawing E 604-SWCR-02 for groove details.
- ⑦ See Standard Drawing E 604-SWCR-02 for details of the detectable warnings.
- ⑧ See Standard Drawing E 604-SWCR-02 for alternate curb construction.
- 9. See Standard Drawing E 604-SWCR-02 for typical ramp construction detail.
- ⑩ Curb or wall shall be used when necessary based on field conditions.
- 11. See Standard Drawings E 604-SWCR-01 and -02 for Location Plan and General Notes respectively.

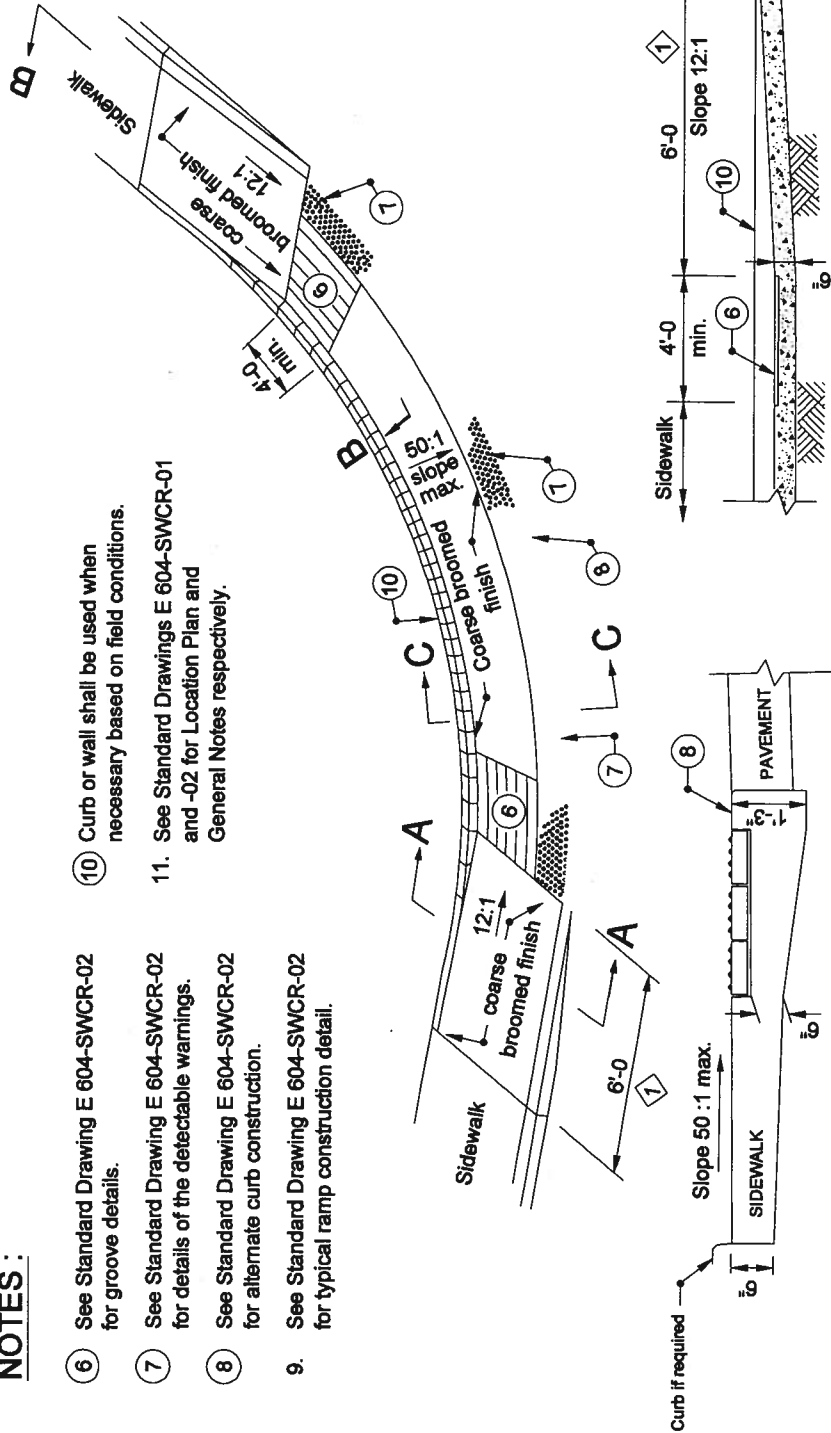

SECTION C-C

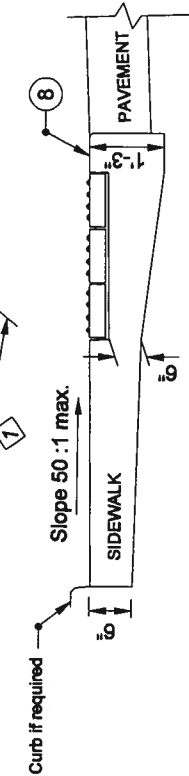

SECTION B-B

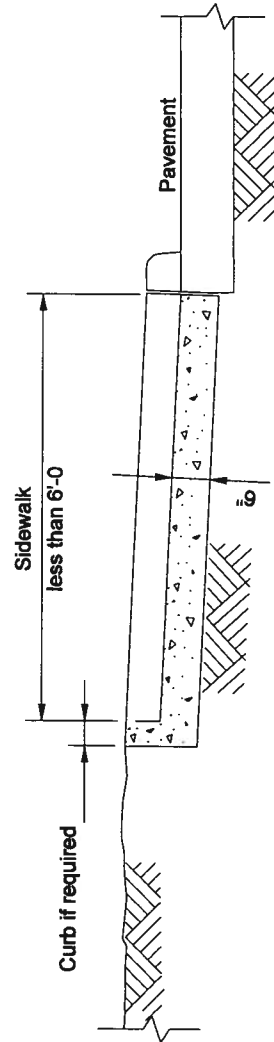
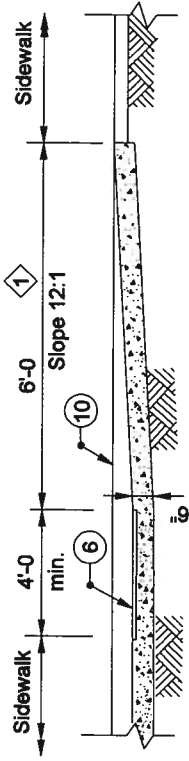

SECTION A-A

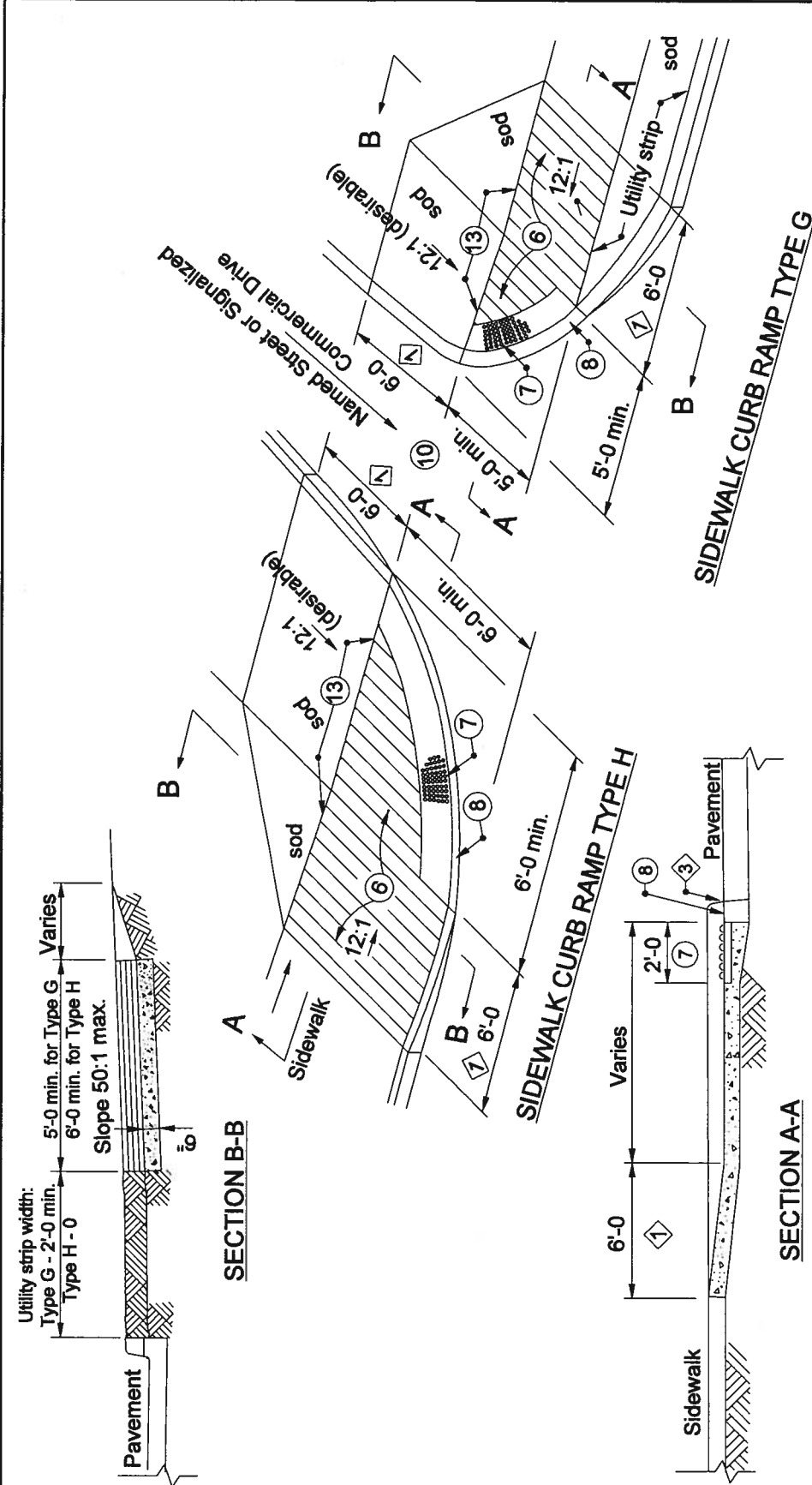

INDIANA DEPARTMENT OF TRANSPORTATION
 SIDEWALK CURB'S RAMP'S
 TYPE G AND TYPE H
 11/01/04

NOTES:

- ⑥ See Standard Drawing E 604-SWCR-02 for groove details.
- ⑦ See Standard Drawings E 604-SWCR-02 for details of the detectable warning surface.
- ⑧ See Standard Drawing E 604-SWCR-02 for alternate curb construction.
- ⑩ Sidewalk across approach shall be sloped at 50:1 maximum transversely.
- 11. See Standard Drawing E 604-SWCR-02 for typical ramp construction detail.
- 12. See Standard Drawing E 604-SWCR-01 and -02 for Location Plan and General Notes respectively.
- ⑬ Vertical face curb optional.

NOTES:

- ⑥ See Standard Drawing E 604-SWCR-02 for groove details.
- ⑦ See Standard Drawing E 604-SWCR-02 for details of the detectable warnings.
- ⑧ See Standard Drawing E 604-SWCR-02 for alternate curb construction.
- ⑨ Match material in place or in plans for median.
- 10. See Standard Drawing E 604-SWCR-02 for typical ramp construction details.
- 11. See Standard Drawing E 604-SWCR-01 and -02 for Location Plan and General Notes respectively.
- 12. Ramp cross slope 50:1 desirable or match grade of roadway.
- 13. Detectable warnings are not required where the roadway crossing is controlled by traffic signals timed to provide full width street crossing by pedestrians.

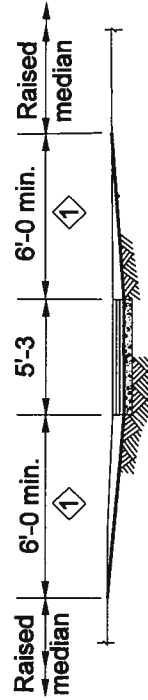
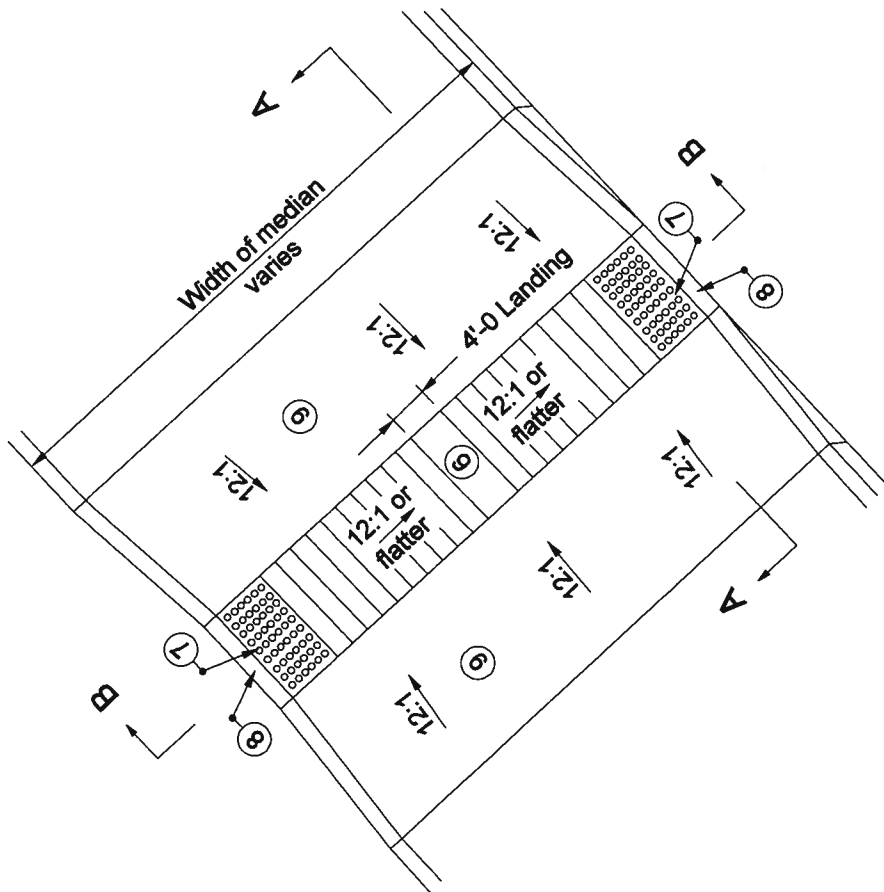

SECTION A-A

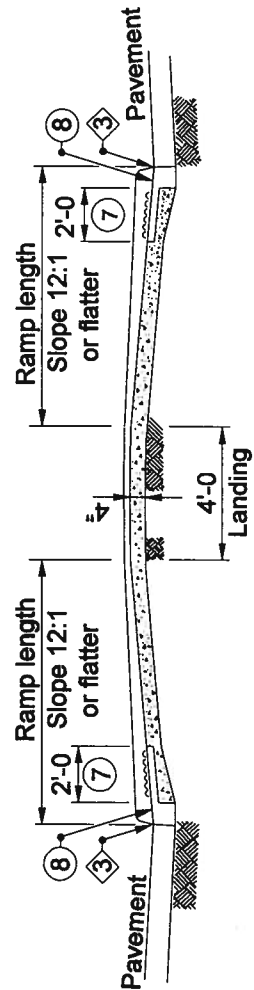

SECTION B-B

INDIANA DEPARTMENT OF TRANSPORTATION
 SIDEWALK CURB RAMPS
 TYPE K
 11/01/04

NOTES:

- ⑥ See Standard Drawing E 604-SWCR-02 for groove details.
- ⑦ See Standard Drawing E 604-SWCR-02 for details of the detectable warnings.
- ⑧ See Standard Drawing E 604-SWCR-02 for alternate curb construction.
- ⑨ Match material in place or in plans for median.
- 10. See Standard Drawing E 604-SWCR-02 for typical ramp construction details.
- 11. See Standard Drawing E 604-SWCR-01 and -02 for Location Plan and General Notes respectively.
- 12. Ramp cross slope 50:1 desirable or match grade of roadway.
- 13. Detectable warnings are not required where the roadway crossing is controlled by traffic signals timed to provide full width street crossing by pedestrians.

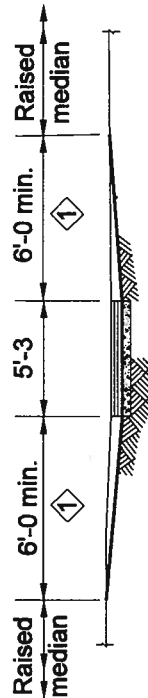
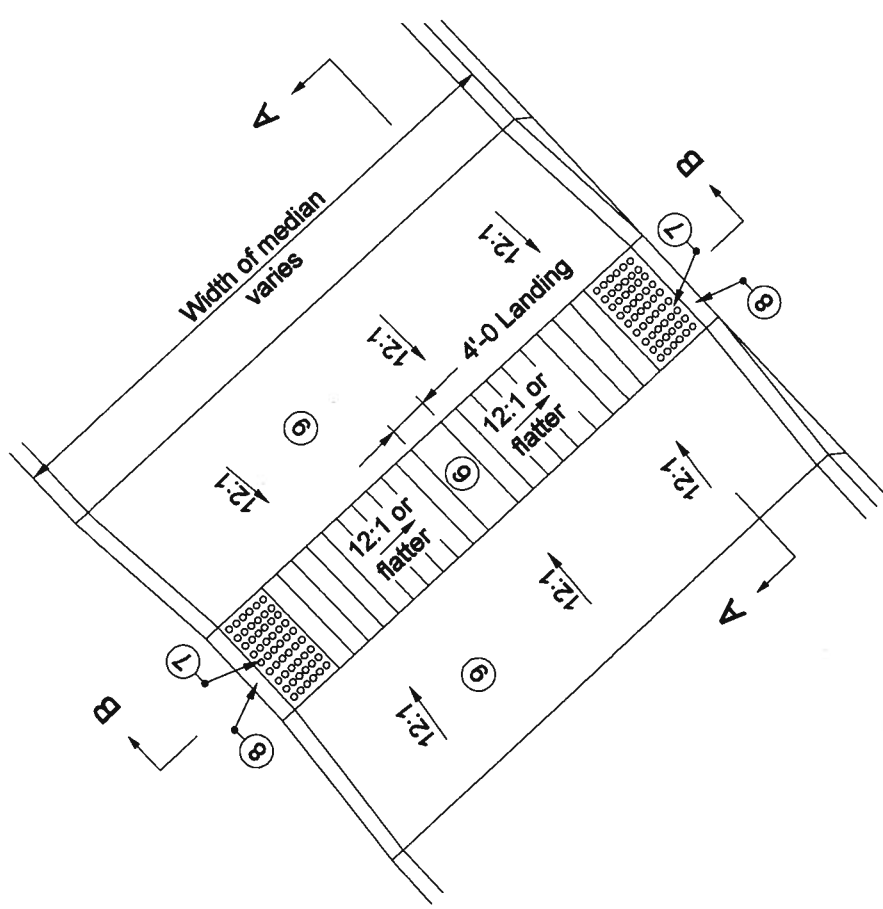

SECTION A-A

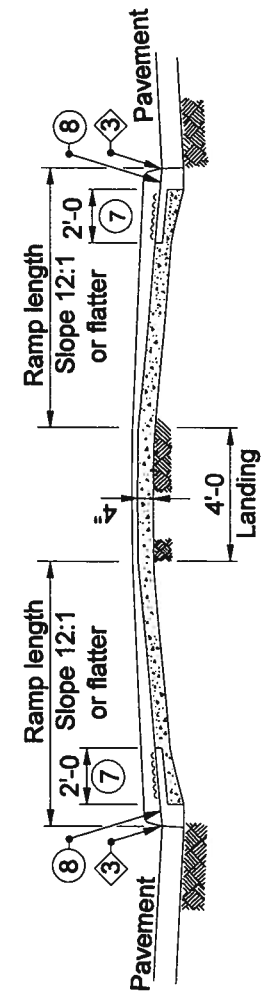

SECTION B-B

INDIANA DEPARTMENT OF TRANSPORTATION
 SIDEWALK CURB RAMPS
 TYPE L
 11/01/04

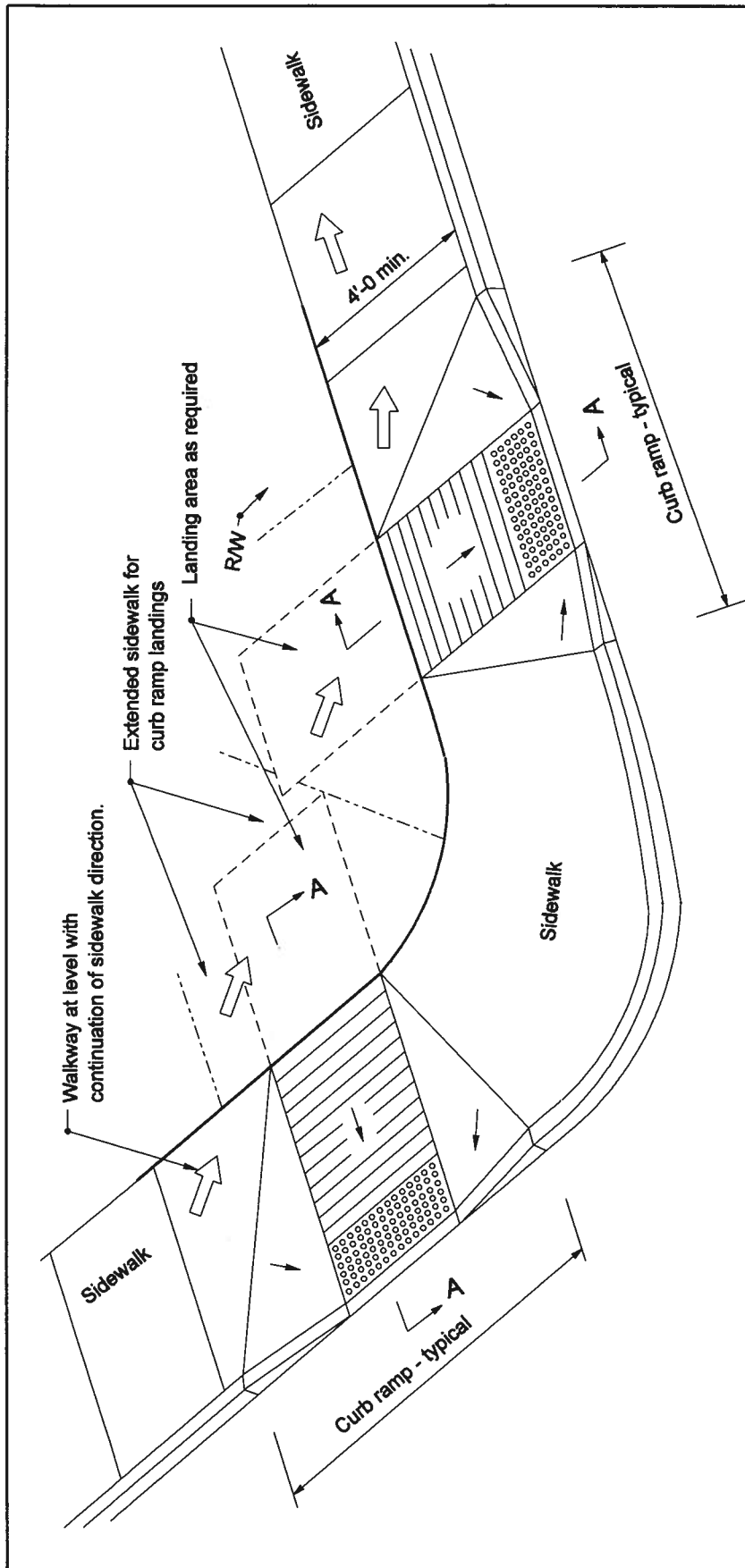

NOTES :

1. Additional right-of-way to widen sidewalks if applicable to improve accessibility on narrow sidewalks.
2. See Standard Drawing E 604-SWCR-02 and -03 to -11 for General Notes and typical curb ramps details respectively.

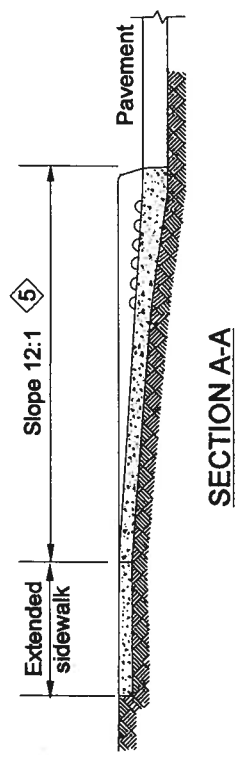

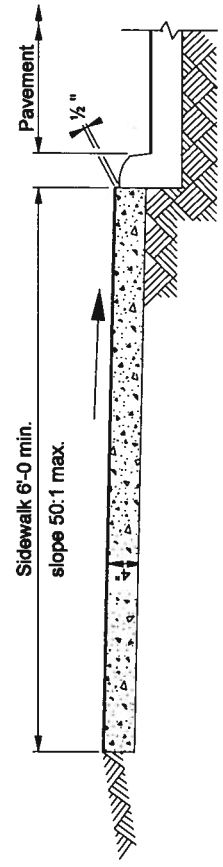
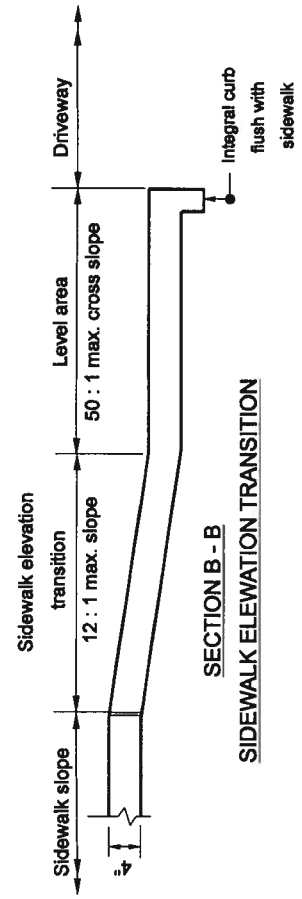
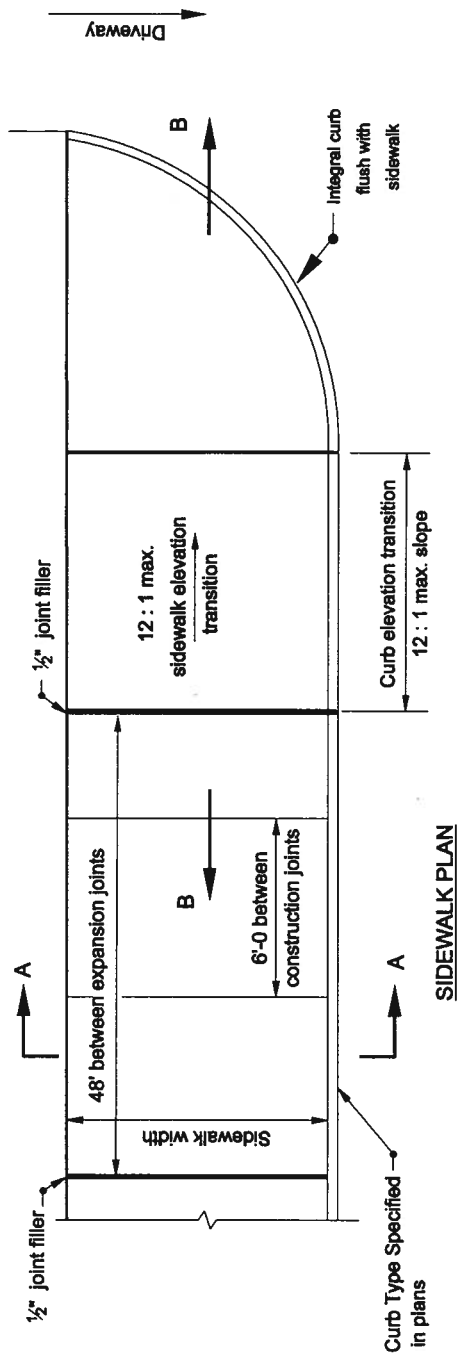

INDIANA DEPARTMENT OF TRANSPORTATION

SIDEWALK DETAILS

SIDEWALK ADJACENT TO CURB

SEPTEMBER 2005

STANDARD DRAWING NO. E 604-SDWK-02

NO. 9750

STATE OF INDIANA

REGISTERED PROFESSIONAL ENGINEER

L. VOORCLAVE

DESIGN ENGINEER

9-02-03

DATE

15/ Richard L. Voorclave

DESIGN STANDARDS ENGINEER

9-02-03

DATE

15/ Richard K. Smutzer

CHIEF HIGHWAY ENGINEER

9-02-03

DATE

DESIGN STANDARDS ENGINEER

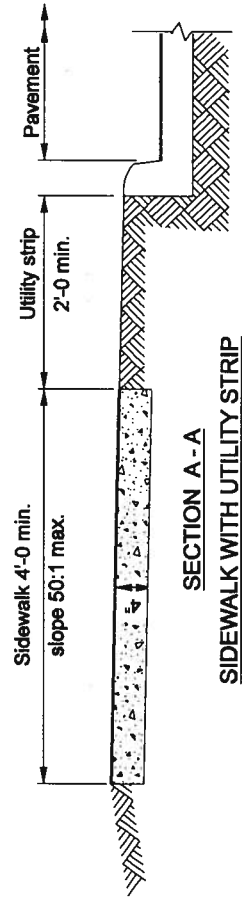
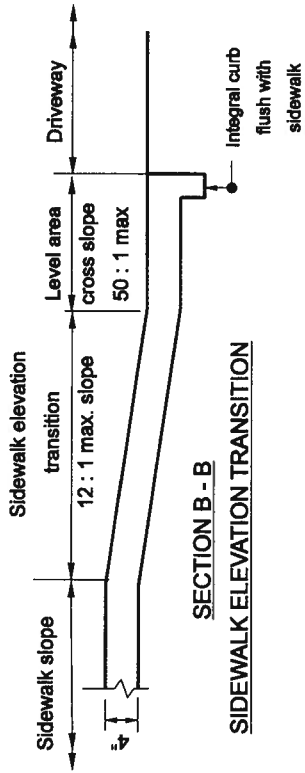
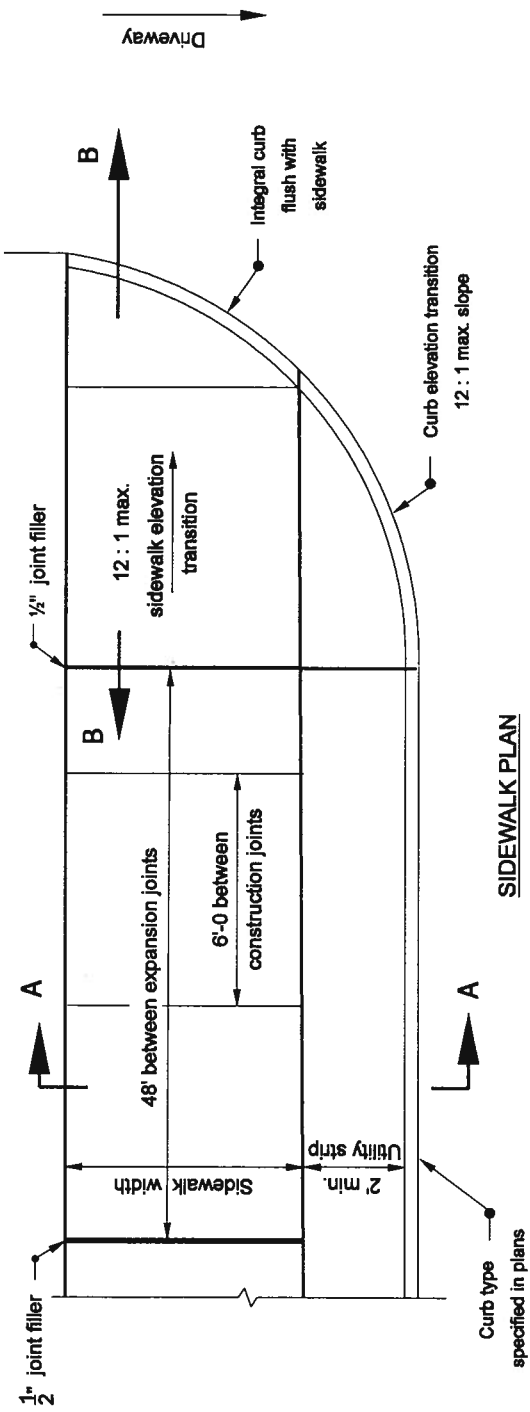

INDIANA DEPARTMENT OF TRANSPORTATION
 SIDEWALK DETAILS
 SIDEWALK WITH UTILITY STRIP
 11/01/04

50 The bottom edge of curb ramps and the top of curb shall be flush with the edge of the adjacent pavement or the gutter line.

The curb ramp running slope shall not exceed 12:1, except where conditions necessitate, a 10:1 slope may be utilized for a maximum rise of 150 mm (6 in.). Curb ramp cross slope shall not exceed 50:1 except where infeasible.

60 **(b) Excavation.** Excavation shall be made to the required depth and to a width that will permit the installation and bracing of the forms. The foundation shall be shaped and compacted to a firm even surface in accordance with the section shown on the plans. All soft and yielding material shall be removed and replaced with acceptable material.

(c) Forms. Forms shall be of wood, metal, or other approved material and shall extend for the full depth of the concrete. Forms shall be straight, free from warp, and of sufficient strength to resist the pressure of the concrete without springing. Bracing and staking of forms shall be such that the forms remain in both horizontal and vertical alignment until their removal.

70 **(d) Placing Concrete.** The foundation shall be thoroughly moistened immediately prior to the placing of the concrete. The proportioning, mixing, and placing of the concrete shall be in accordance with 702. The thickness of the concrete in the curb ramp, including flared sides, shall be as shown on the plans for the type specified.

(e) Finishing. The surface shall be finished with a wooden float. No plastering of the surface will be permitted. Ramp surfaces shall be coarse broomed and corrugated transverse to the slope as shown on the plans. The surface texture of the flared sides shall be coarse broomed with the striations transverse to the slopes.

80 All exposed edges shall be finished with a 6 mm (1/4 in.) radius.

(f) Joints. The type and location of joints and the size of preformed joint filler shall be as shown on the plans.

All concrete joints shall be finished with a 6 mm (1/4 in.) radius.

90 Preformed 13 mm (1/2 in.) joint filler shall be placed around all appurtenances, such as manholes and utility poles which extend into and through the sidewalk, and between the sidewalk and any fixed structure, such as a building or bridge. The preformed joint filler shall extend for the full depth of the sidewalk or curb ramp, and shall be flush with the surface of the adjacent concrete.

(g) Detectable Warning Elements. Detectable warning elements shall be as shown on the plans. They shall be set in a thin set mortar on top of the concrete base. The concrete base shall be cleaned of all materials which might prevent the mortar from adhering to the base. The mortar shall be applied to the concrete in accordance with the manufacturer's recommendations. Where elements smaller than full sized are needed, whole elements shall be cut full depth with an appropriate power saw.

100

Brick joints shall be hand tight with a maximum of 1.5 mm (1/16 in.) width.

The joints between bricks shall be filled with a fine aggregate No. 15 or an equivalent sand. This filling shall be accomplished by repeated brooming of the aggregate across the face of the bricks. Excess aggregate shall then be removed from the surface.

110

(h) Curing. Concrete shall be cured for at least 72 h. Curing shall be in accordance with 504.04 except curing compound shall not be used in the area where detectable warning elements are to be installed. During the curing period all pedestrian traffic shall be excluded.

(i) Painting. The exposed surfaces of the curb throughout the width of curb ramps shall be painted yellow in accordance with 808.06. Silica sand shall be applied to the wet paint along the top of the curb at the rate of 0.7 kg/L (6.0 lb/gal.).

604.04 PCC Steps. PCC steps shall be in accordance with the applicable provisions of 604.03. In addition, all exposed edges shall be rounded to a 6 mm (1/4 in.) radius.

120

604.05 Reconstructed PCC Sidewalk. Where existing concrete sidewalk is to be reconstructed, all disintegrated concrete, brick, stone, or other material shall be completely removed and replaced with new concrete sidewalk in accordance with 604.03.

Such sidewalk shall be constructed to a minimum depth of 100 mm (4 in.) unless another depth is designated and to the width of the adjoining walk, or to a width of no less than 1200 mm (48 in.) from the face of curb, or to such other width as directed.

130

The removal of concrete sidewalk shall be to uniform lines as directed. The sidewalk to be removed shall be cut in a straight line with an approved power driven concrete saw. The sawing shall be such that the portion of sidewalk to remain in place shall not be damaged. All portions which are damaged or removed back of the established line shall be replaced.

Unless otherwise directed, sidewalk which must be removed shall be removed between tool marks or joints. At locations where the sidewalk and curb are adjacent and the curb is deteriorated, the curb shall also be replaced as directed.

140

The new sidewalk shall have a joint pattern similar to the surrounding sidewalk. Sidewalk placed at drives shall be 150 mm (6 in.) thick, or the same depth of the existing drive, whichever is greater.

604.06 Re-Laid Sidewalk. This work consists of the removal and re-laying of concrete, stone-slab, or brick sidewalk at the locations shown on the plans or as directed. In the operations of removing and re-laying, care shall be taken not to damage any of the sidewalk. Before re-laying, a cushion of fine aggregate shall be spread on the

30 **905.04 Precast Concrete Riprap.** Precast concrete riprap shall consist of unreinforced concrete units of the thickness specified and shall be in accordance with the details shown on the plans. The precast concrete units shall be in accordance with ASTM C 139 except the fine aggregates shall be in accordance with 904.02(a) and the coarse aggregates, class A or higher, shall be in accordance with 904.03. The minimum compressive strength shall be 17 MPa (2500 psi) for an average of three units and 16 MPa (2300 psi) for individual units. The maximum water absorption shall be 190 kg/m³ (12 lb/cu ft) for an average of three units.

905.05 Detectable Warning Elements. Detectable warning bricks used in sidewalk curb ramps shall be in accordance with ASTM C 902, Class SX, Type II. The color shall approximate 30109 or 30166 in accordance with Federal Standard No. 595a. The color shall be consistent throughout the brick. The truncated domes shall be as shown on the plans. The minimum dimensions of the brick shall be 60 mm (2 1/4 in.) thick by 90 mm (3 5/8 in.) wide by 195 mm (7 5/8 in.) long. The minimum thickness shall not be measured within the area of the domes.

SECTION 906 – JOINT MATERIALS

906.01 Joint Fillers. Joint fillers shall be preformed materials intended to be used in PCCP and bridge joints or as otherwise specified. Joint fillers shall be in accordance with AASHTO M 153. The asphalt content will be determined in accordance with ITM 801.

906.02 Joint Sealing Materials.

10 (a) **Joint Sealers.** Joint sealers shall consist of materials which are intended to be used in sealing joints and cracks in pavements and structures.

1. Silicone Joint Sealants.

a. **Physical Requirements.** Silicone joint sealants shall be in accordance with ASTM D 5893.

20 b. **Field Evaluation.** All silicone joint sealants complying with the physical requirements will be subjected to a field evaluation before approval for general use is granted. The Department will maintain a List of the Joint Sealants which comply with the physical requirements and field evaluation.

c. **Specific Requirements for Installation of Silicone Joint Sealant.** The sealant shall be stored in the original unopened container at or below 32°C (90°F). The sealant shall be placed when the ambient temperature is above 4°C (40°F). The equipment used shall be adequate for the placement of the sealant and shall meet the sealant manufacturer's recommendations. Air compressors used for the placement of this sealant shall be equipped with traps which remove moisture and oil from the air.

30 The approved sealants which are self leveling shall be identified as such on the Approved List of Joint Sealants and will not require tooling. Sealants not identified as self leveling on the approved list shall be tooled or applied in such a manner which

AMERICANS WITH DISABILITIES ACT ---

CURB RAMP PROGRAMS

by Ed Ratulowski, P.E., Design Engineer, Indiana FHWA

Most, if not all, cities, towns, and counties in Indiana have been installing curb ramps for the disabled since the 1970's. The majority of the earlier installations were made on Federally funded street projects as a result of a requirement in Section 504 of the 1973 Rehabilitation Act. Section 504 required curb ramps on projects with sidewalks that utilized Federal funds.

The Americans with Disabilities Act (ADA), which was passed on July 26, 1990, drastically changed the requirements relative to curb ramp installations. The implementing regulation, which was published in the Federal Register on July 26, 1991 by the Department of Justice, had three basic requirements and accompanying target dates for all public entities that have sidewalks under their jurisdiction. They are:

1. By July 26, 1992 complete a Transition Plan*
 2. By January 26, 1993 accomplish a Self Evaluation
 3. By July 26, 1995 install curb ramps throughout the public entity's area
- * Written Transition Plans are only required for public entities with 50 or more employees. Public entities with less than 50 employees are still required to meet the target date for installing curb ramps throughout their areas.

Many of you are probably unfamiliar with the terms "Self-evaluation" and "Transition Plan". Therefore, the following description of what each should involve will be of interest:

SELF EVALUATION

This is essentially an evaluation of current practices and procedures pertaining to all aspects of curb ramps and implementation of needed changes to be in compliance with ADA requirements.

Some of the questions that a public entity must address in the evaluation are:

1. Do you have an ADA Coordinator?
2. Is the name of the ADA Coordinator published in the local phone book under government offices and/or in the yellow pages under handicapped services?
3. Are receptionists and others answering phones at government offices aware of the name of the ADA Coordinator and the coordinator's telephone number?
4. Do you have published grievance procedures providing for prompt and equitable resolution of complaints about curb ramps.
5. Have you completed an inventory of your entire city, town or county to determine where curb ramps are non-existent, non-standard and standard? The inventory is essential to determine the extent of curb ramp needs and the financial resources that will be required to fulfill those needs in a reasonable length of time. When conducting the inventory it would be desirable to inventory sidewalks and their condition. Very little is accomplished by installing curb ramps if the sidewalks are not traversable by persons in wheelchairs.

TRANSITION PLAN

A Transition Plan is a prioritized schedule for installation of new curb ramps and for upgrading those that are substandard. The Transition Plan should include the following:

1. The person responsible for implementing the Transition Plan
2. Written procedures for receiving and resolving curb ramp complaints
3. A prioritized listing of curb ramps to be installed based on high demand areas such as hospitals, doctor's of-

fices, schools, public buildings, medical equipment stores, neighborhood areas with handicapped persons in wheelchairs, etc.

4. A listing of lower priority areas where curb ramps need to be installed and possibly coordinated with sidewalk replacement programs and street resurfacing.
5. The number of curb ramps to be installed or upgraded each year.
6. Financial Resources needed and sources.

In developing the Transition Plan it is required that there be public input from public hearings held on the draft Transition Plan. It is also helpful to obtain input during development of the Transition Plan from organizations representing the disabled.

There has been significant effort over the years to obtain a time extension beyond the July 26, 1995 target date for completing the installation of curb ramps. However, the Department of Justice decided to retain the July 26, 1995 date realizing that most public entities have not met this date. Therefore, it is imperative that public entities strive to have a Transition Plan in place and make a good faith effort to complete it.

The Federal Highway Administration is planning to visit a sampling of public entities, in the not to distant future, to provide assistance to assure they have accomplished a "Self Evaluation" and have a "Transition Plan". FHWA believes this "proactive" approach is a better way to manage the issue rather than performing audits after a complaint is made to the Department of Justice against a public entity.

Further information on this subject can be obtained by calling the Disability and Business Technical Assistance Center at 1-800-949-4232. One can also visit the ADA website at <http://www.access-board.gov>, or contact Ed Ratulowski, FHWA Indiana, directly at 317-226-7342.